



Take a Closer Look at Quantum's Glazing Process

Today's architectural features increasingly call for larger expanses of glass that require innovative approaches which blend structural performance with aesthetic design. Quantum Windows & Doors builds advanced systems that provide a visual connection to the world outside while enhancing the comfort and security of the spaces in which we work and live.

Quantum is known throughout the industry for producing products with high optical quality. This is a result of stringent criteria for selecting glass and choosing performance based components with which to fabricate our Insulated Glazed Units (IGU's) in-house.

Glass Glass type is generally project specific and determined by preference, performance requirements or local building codes. Only the parts of the sheet glass that meet Quantum's industry leading standards are selected and used, and the rest is recycled.

Seal Glazing performance and durability is determined by the integrity of the seal. All of Quantum's insulated units are dual-sealed utilizing a specialized foam spacer, along with hot melt butyl sealant. Unlike metal spacers, Quantum's spacers are manufactured with engineered foam that is flexible, non-conductive, and mold resistant. In addition to creating a cleaner shadow line, they absorb sound, withstand 140 degree temperatures, 95-100% humidity and UV rays. Quantum's spacer system when combined with our hot melt butyl creates a dual seal that lasts up to 5 times longer than single sealed units. Consequently we offer the longest IGU warranty in the custom window industry - 15 years.

Installing IGU's All Quantum's products are *wet glazed with sealants* as opposed to using double sided tape. This gives our products better performance, increased durability and strength. Our IGU's are bedded into a layer of silicon and latex and then stopped in by hand using silicon and latex, as well as a silicon glazing sealant. Glazed units are then cured for 24 hours and cleaned before final inspection.

Optional Glazing Applications Quantum offers a wide variety of glazing options including but not limited to custom sticking and stop profiles, true divided lites, applied lead, art glass, argon fill, tempered, tinted, obscure, sound control, and laminated.

For more information please contact your Quantum Representative



TRUE DIVIDED LITE

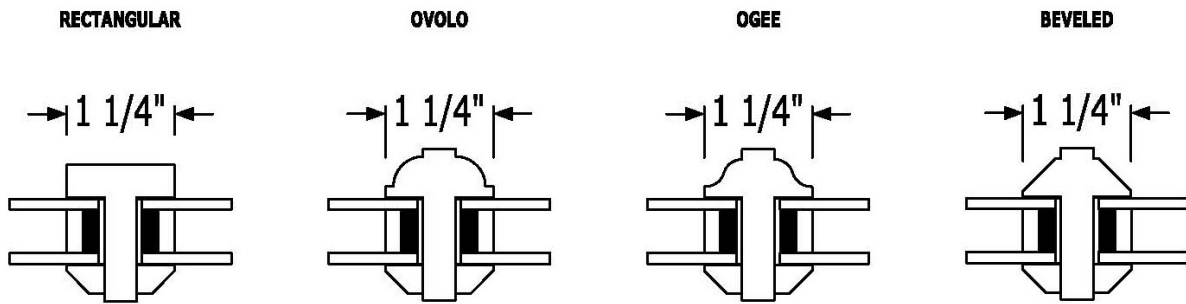

SIMULATED DIVIDED LITE

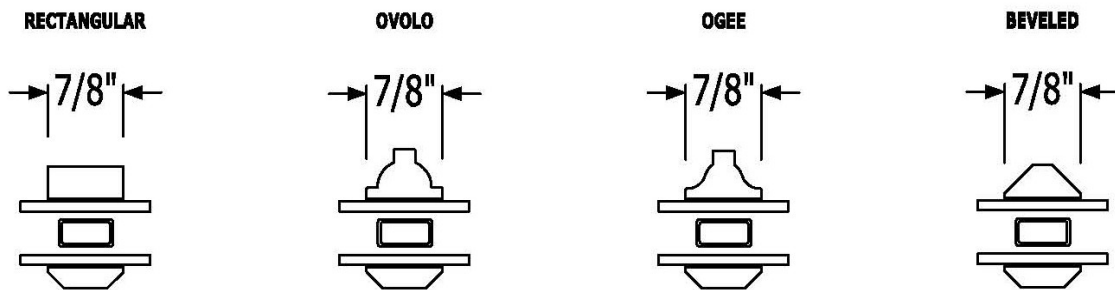

APPLIED LEAD

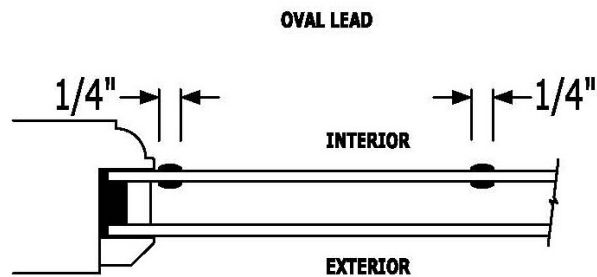
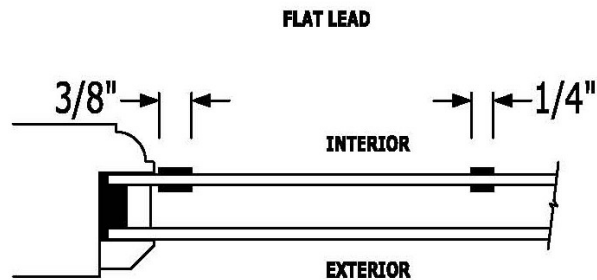

For more information please contact your Quantum Representative



Glazing

Panel Options

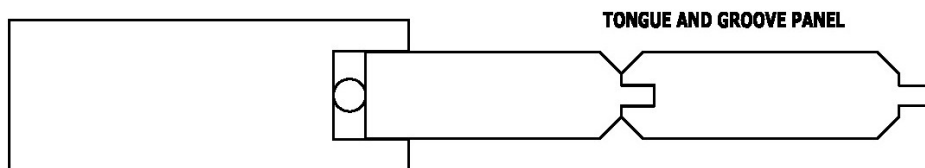
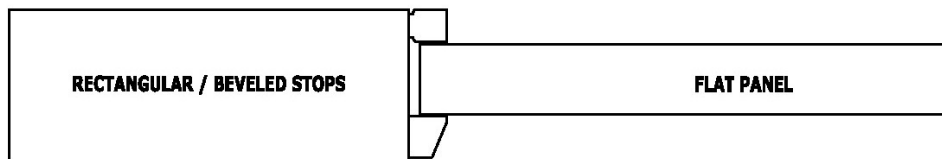
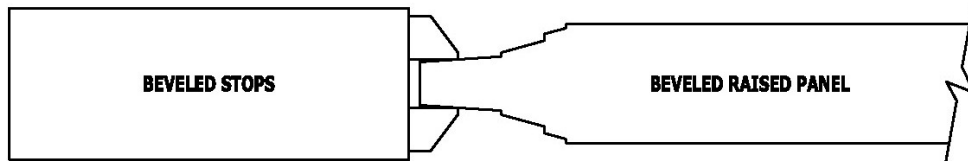
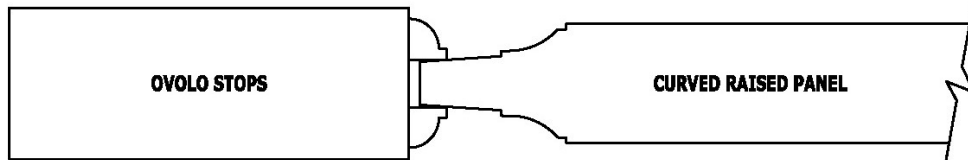

For more information please contact your Quantum Representative